

CV-5005ZA

HDMI 2.0a Re-timer / EDID Recorder
with Audio Support

User Manual



 x.v.Color

71 CH
AUDIO



rev: 160811
Made in Taiwan



Safety and Notice

The **CV-5005ZA HDMI 2.0a Re-timer / EDID Recorder with Audio Support** has been tested for conformance to safety regulations and requirements, and has been certified for international use. However, like all electronic equipments, the CV-5005ZA should be used with care. Please read and follow the safety instructions to protect yourself from possible injury and to minimize the risk of damage to the unit.

- Follow all instructions and warnings marked on this unit.
- Do not attempt to service this unit yourself, except where explained in this manual.
- Provide proper ventilation and air circulation and do not use near water.
- Keep objects that might damage the device and assure that the placement of this unit is on a stable surface.
- Use only the power adapter and power cords and connection cables designed for this unit.
- Do not use liquid or aerosol cleaners to clean this unit. Always unplug the power to the device before cleaning.



TABLE OF CONTENTS

INTRODUCTION.....	1
FEATURES.....	1
PACKAGE CONTENTS	2
SPECIFICATIONS	2
PANEL DESCRIPTIONS.....	3
CONNECTION DIAGRAM	4
HARDWARE INSTALLATION.....	5
OPERATION SOFTWARE.....	6
LIMITED WARRANTY	9

INTRODUCTION

The **CV-5005ZA HDMI 2.0a Re-timer / EDID Recorder with Audio Support** is a device that can emulate the EDID (Extended Display Identification Data) information. It stores and recalls a default EDID setting in non-volatile memory and supports HDCP handshaking. CV-5005ZA allows your HDMI source to boot directly from EDID Reader/Writer/Re-timer, and users can detach HDMI equipped monitor at any time while installing CV-5005ZA between HDMI source and monitor. It can also read and store the EDID of your HDMI/DVI display and even let you modify the EDID and upload the modified EDID to displays.



Extended Display Identification Data (EDID) is a standard data format that contains basic information about a monitor and its capabilities, including vendor information, maximum image size, color characteristics, factory pre-set timings, frequency range limits, and character strings for the monitor name and serial number.

The information is stored in the display and is used to communicate with the system through a Display Data Channel (DDC), which sits between the monitor and the PC graphics adapter. The system uses this information for configuration purposes, so the monitor and system can work together.

FEATURES

- HDMI 2.0a compliant
- Supports 4K2K@60 4:4:4 8bits
- Supports HDR*, which is 4K2K@60 4:2:0 10bits**
- HDCP 2.2 compliant
- Supports resolution upscaling from 1080p to 4K2K or downscaling from 4K2K to 1080p (No frame rate conversion)
- Supports HDMI signal bypass
- Simultaneous HDMI output
- Able to read and store the EDID of displays (monitors or projectors)
- Able to overwrite the EDID into the EDID Reader/Re-timer
- Built-in default EDID
- Able to maintain HDMI/DVI video resolution
- Re-synthesizes input HDMI stream and maintains or improves signal integrity.
- Extracts Stereo audio from HDMI input



* HDR = High Dynamic Range.

** The video bandwidth of 4K2K@60 4:2:0 10bits (HDR) is 384 MHz, and the 4K2K@60 4:4:4 8bits is 594MHz.

PACKAGE CONTENTS

- 1x CV-5005ZA
- 1x 5V power supply unit
- 1x Installation software CD
- 1x User Manual

SPECIFICATIONS

Model Name		CV-5005ZA
Technical		
HDMI compliance		HDMI 2.0a
HDCP compliance		HDCP 2.2
Video bandwidth		Single-link 600MHz [18Gbps]
Video support		HDR 4K2K@60 (4:2:0 10bits) / 4K2K@60 (4:4:4 8bits)
Input		1x HDMI 1x mini-USB
Output		2x HDMI + 1x Stereo
HDMI connector		Type A [19-pin female]
USB connector		Type mini-USB
Mechanical		
Housing		Metal enclosure
Dimensions [L x W x H]	Model	95x 83 x 27mm[3.7" x 3.3" x 1.1"]
	Package	264 x 170 x 77mm[10.3" x 6.7" x 3"]
	Carton	430 x 358 x 291mm[1'4" x 1'2" x 11.5"]
Weight	Model	275g [9.7oz]
	Package	587g [1 lbs]
Fixedness		Wall-mounting case with screws
Power supply		5V 2A DC
Power consumption		4 Watt [max]
Operation temperature		0~40°C [32~104°F]
Storage temperature		-20~60°C [-4~140°F]
Relative humidity		20~90% RH [no condensation]

PANEL DESCRIPTIONS

Front Panel

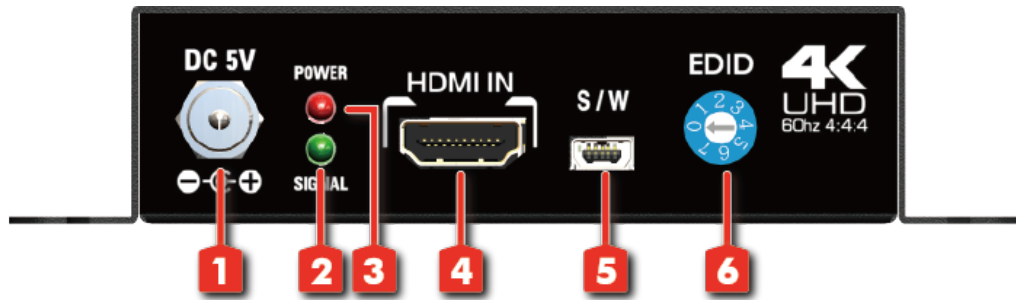

- 1. +5V DC:** Connect to a 5V power supply unit
- 2. Green LED:** Green light means the signal detected.
- 3. Red LED:** Power on/off indicator
- 4. SOURCE:** Link to a HDMI source in order to be the bridge between HDMI source and display
- 5. Mini-USB:** Connect to a host device for software operation
- 6. MODE:** Decide which mode CV-5005ZA is currently working at.

MODE:

0 = User define mode

1 - EDID Ultra-HD(4K2K@60) - 24bit 2D video & 7.1ch audio

2 - EDID Ultra-HD(4K2K@60) - 24bit 2D video & 2ch audio

3 - EDID Ultra-HD(4K2K@30) - 24bit 2D video & 7.1ch audio

4 - EDID Full-HD(1080p@60) - 24bit 2D video & 7.1ch audio

5 - EDID Full-HD(1080p@60) - 24bit 2D video & 2ch audio

6 - EDID HD(1080p@30)(1080i@60)(720p@60) - 24bit 2D video & 2ch audio

7 = [Manual Mode] – Learning EDID from HDMI DISPLAY 2 to HDMI input manually

Rear Panel

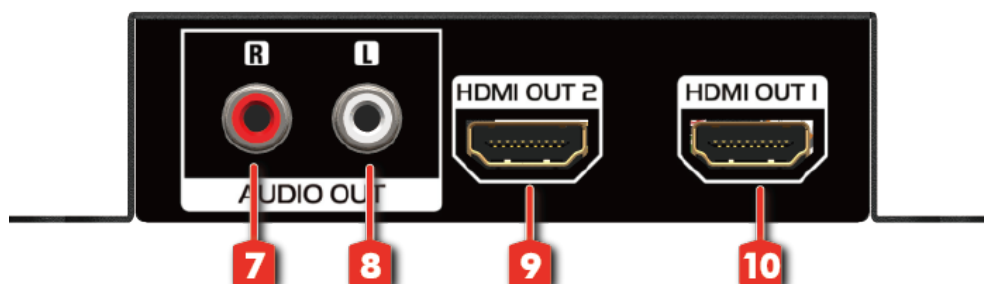

- 7. Stereo audio output - R**
- 8. Stereo audio output - L**
- 9. DISPLAY 2 :** Connect to a HDMI display 2
- 10. DISPLAY 1 :** Connect to a HDMI display 1

CONNECTION DIAGRAM

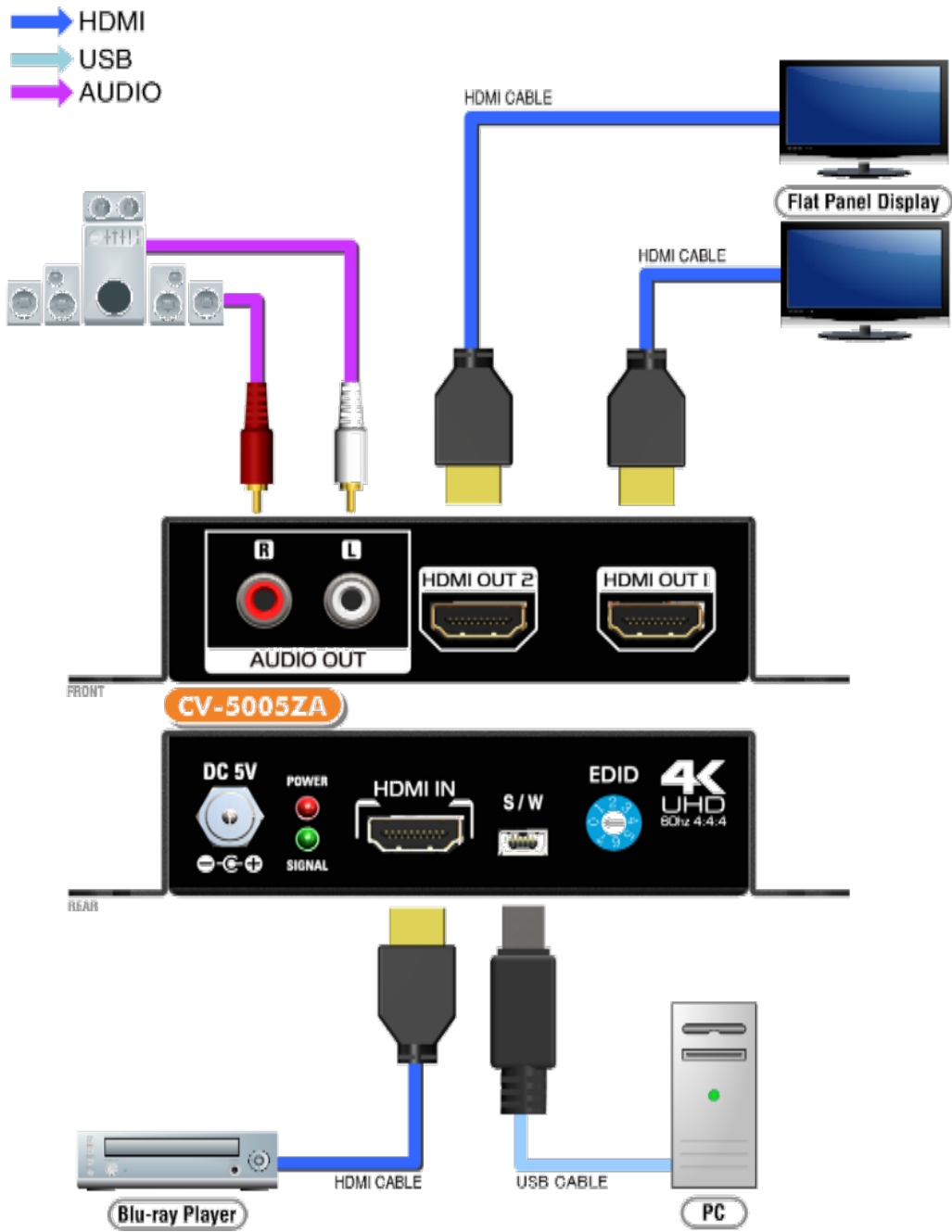

HARDWARE INSTALLATION

1. Learn the EDID from a HDMI display to the HDMI input manually

1. Connect the display device to the EDID Recorder via **HDMI DISPLAY 2**.
2. Plug in the 5V DC power supply unit.
3. Set CV-5005ZA to the mode 7 from 0 or 6.
4. Hold the mode at 7 until next learn the EDID process.

2. Recall the EDID from a HDMI display or user defined EDID data via software

1. Set CV-5005ZA to the mode 0.
2. Connect the display device to the EDID Recorder via **HDMI Display** port.
3. Plug in the 5V DC power supply unit.
4. Connect the CV-5005ZA to PC via USB cable
5. Click on “Read EDID from Monitor 1” or “Read EDID from Monitor 2” button or load the user defined EDID data.
6. Click on “Write EDID into Device”, the EDID from display will be written to CV-5005ZA device on mode 0.
7. Hold the mode at 0 until next update the EDID process.

Getting Started:

Your Computer System Requires:

The software supports Windows XP consistently. Both Windows7 and Windows 8 are supported after manually configuring the compatibility properties.

Windows7 and Windows 8: Please configure the compatibility properties manually.

Step1. Right-click the link for the software that you want to configure, and then click Contents.

Step2. On the Compatibility tab, click Run this program in compatibility mode.

Start Software:

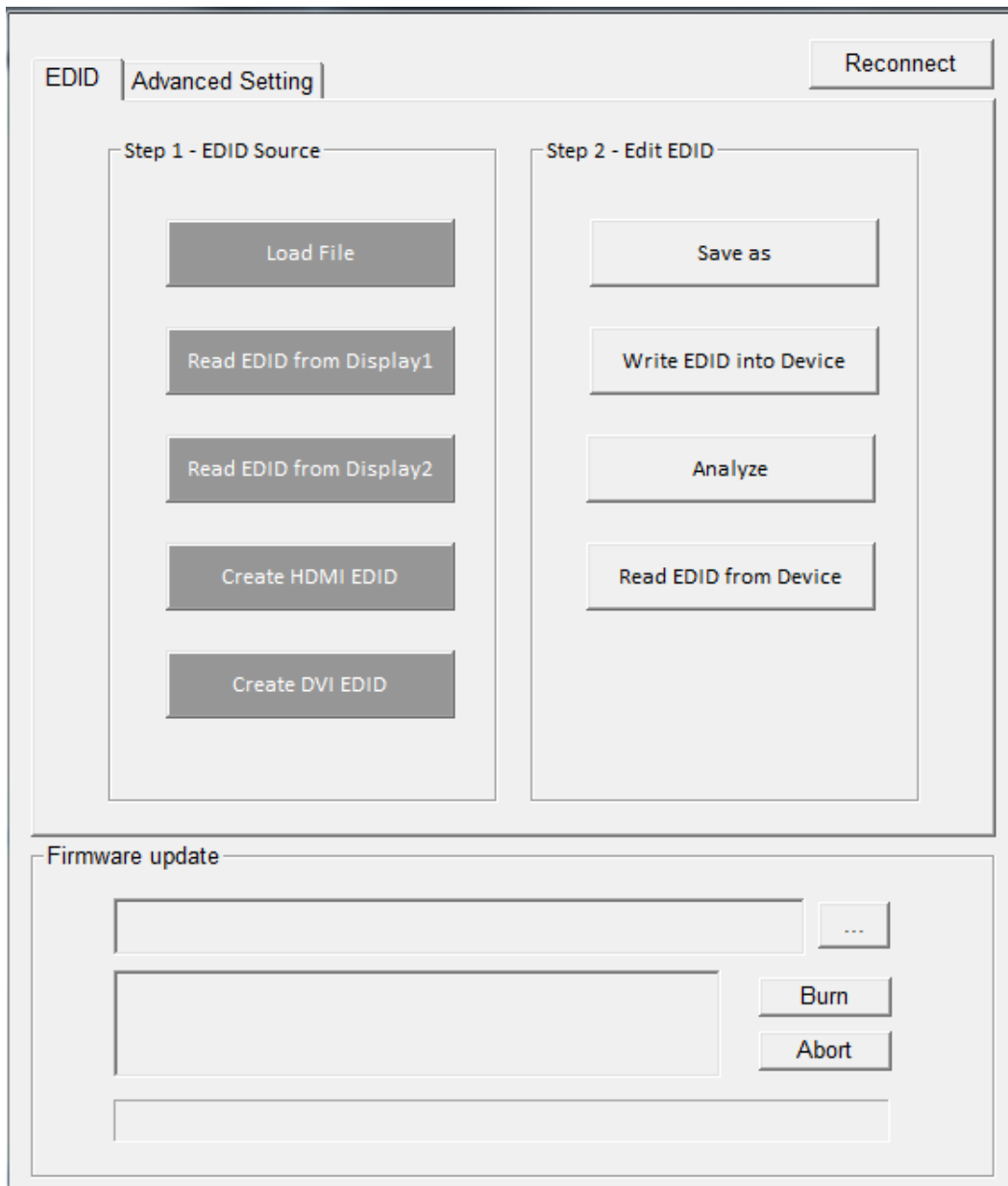

EDID

a) Step 1: Select EDID Source

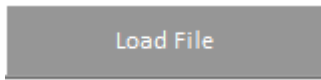

: To select EDID source by loading the file you saved.

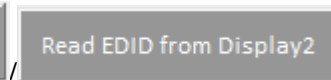
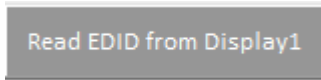

: To read EDID info from the connected display.

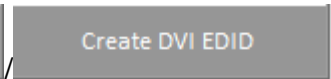
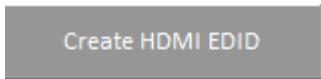

: To create EDID source which users are capable of monitoring or modifying.



The selected EDID source will be highlighted in red.

b) Step 2: Edit EDID

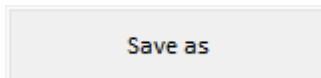

: To save the EDID information to computer for future use.

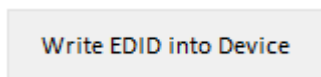

: To write EDID information into the CV-5005ZA device

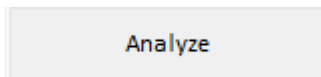

: To make a quick analysis of EDID information you process, which users are capable of monitoring or modifying.

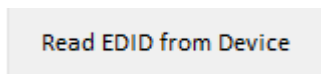

: To read the EDID that is currently used in CV-5005ZA

c) Firmware update

Update FW to the device

a. Click  to load the FW and update it to CV-5005ZA device

b. Click , then re-cycle power to start the FW update process

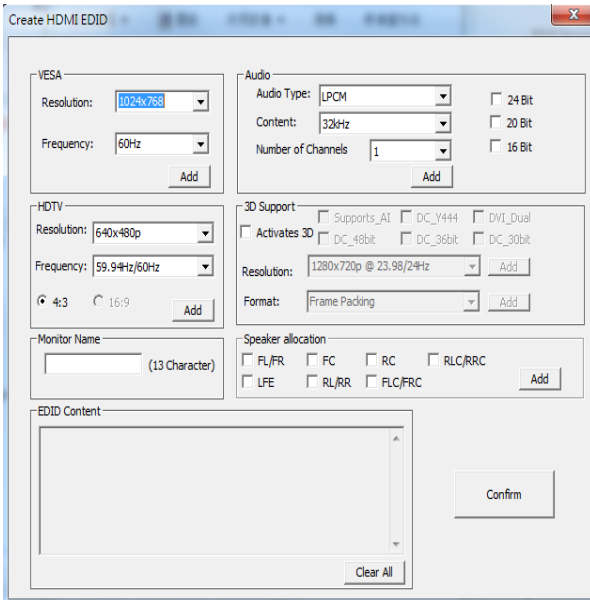

Create HDMI EDID

Create HDMI EDID

1. Click  to pop-up the HDMI EDID edition page, which users are capable of monitoring or modifying HDMI EDID here.
2. Please click "Add" button for your chosen.
3. Finally please click "Confirm" button to generate EDID and then you will see the success message.

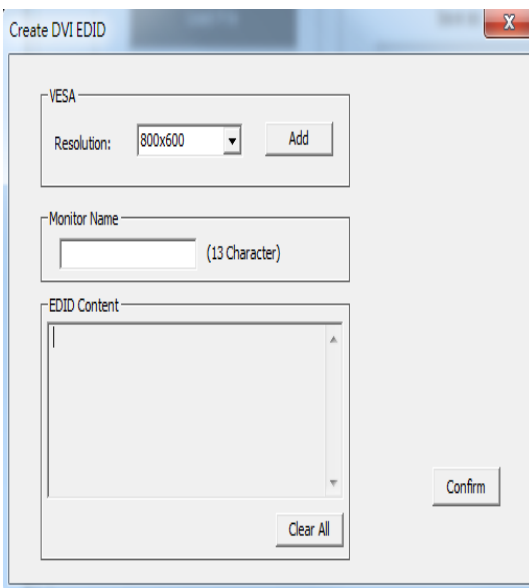

Create DVI EDID

Create DVI EDID

1. Click  to pop-up the DVI EDID edition page, which users are capable of monitoring or modifying DVI EDID here.
2. Please click "Add" button for your chosen.
3. Finally please click "Confirm" button to generate EDID and then you will see the success message.

Analyze

Analyze

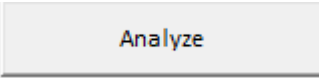
1. Click  to make a quick analysis on the EDID information you process.

View Detail: To make a quick analysis on the EDID information.

Edit: users are capable of monitoring or modifying EDID information.

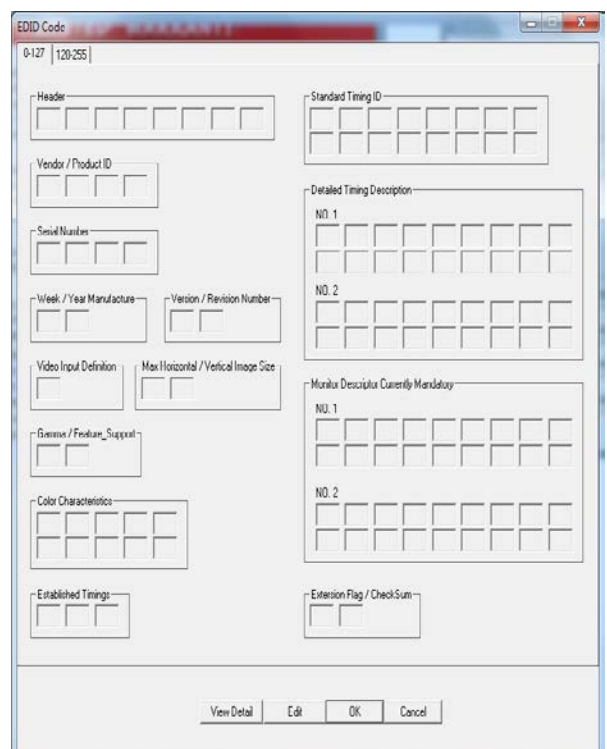

LIMITED WARRANTY

The SELLER warrants the **CV-5005ZA HDMI 2.0a Re-timer / EDID Recorder with Audio Support** to be free from defects in the material and workmanship for 1 year from the date of purchase from the SELLER or an authorized dealer. Should this product fail to be in good working order within 1 year warranty period, The SELLER, at its option, repair or replace the unit, provided that the unit has not been subjected to accident, disaster, abuse or any unauthorized modifications including static discharge and power surge. This warranty is offered by the SELLER for its BUYER with direct transaction only. This warranty is void if the warranty seal on the metal housing is broken.

Unit that fails under conditions other than those covered will be repaired at the current price of parts and labor in effect at the time of repair. Such repairs are warranted for 90 days from the day of reshipment to the BUYER. If the unit is delivered by mail, customers agree to insure the unit or assume the risk of loss or damage in transit. Under no circumstances will a unit be accepted without a return authorization number.

The warranty is in lieu of all other warranties expressed or implied, including without limitations, any other implied warranty or fitness or merchantability for any particular purpose, all of which are expressly disclaimed.

Proof of sale may be required in order to claim warranty. Customers outside Taiwan are responsible for shipping charges to and from the SELLER. Cables and power adapters are limited to a 30 day warranty and must be free from any markings, scratches, and neatly coiled.

The content of this manual has been carefully checked and is believed to be accurate. However, The SELLER assumes no responsibility for any inaccuracies that may be contained in this manual. The SELLER will NOT be liable for direct, indirect, incidental, special, or consequential damages resulting from any defect or omission in this manual, even if advised of the possibility of such damages. **Also, the technical information contained herein regarding the features and specifications of CV-5005ZA is subject to change without further notice.**